

OPERATING AND INSTALLATION INSTRUCTIONS

SINGLE AND DUAL HEAT EXCHANGER DOMESTIC HOT WATER TANKS FOR SOLAR, GEOTHERMAL OR HYDRONIC APPLICATIONS

» SBB 300, 400 S & SBB 300, 400, 600 PLUS

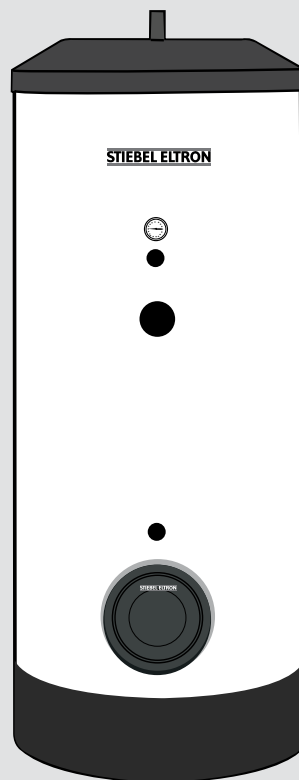

STIEBEL ELTRON



SBB tanks are ETL certified in US & Canada to IAS U.S. Requirements for Indirect Fired Water Heaters For Use With External Heat Source. No 1-91, Dated June 6, 1992.



Tested and certified by WQA to NSF/ANSI 372 for lead free compliance.

1. CONTENTS

SECTION	PAGE
1. Contents	2
2. Safety Instructions	3
3. Operation and Service	4
3.1 Start-up	4
4. Maintenance and Cleaning	4
4.1 Pressure Relief Valve	4
4.2 Decalcification	4
4.3 Sacrificial Anode - Inspection / Replacement	4
5. Failures - Cause - Correction	5
6. Technical Specifications	5
6.1 Technical Data & Specifications	6
6.2 Dimensions	7
7. Installation Instructions - General	8
7.1 Set-up	8
7.1.1 Brief Description of the Appliance - Applications	8
7.1.2 Connections	8
7.2 Delivery Configuration	8
7.3 Tasks to be performed by Installer	8
7.4 Regulations and Standards	8
8. Set-up and Installation	9
8.1 Set-up	9
8.2 Connections	9
8.3 Heater Installation	9
8.4 Hot Water Installation	9
8.4.1 Local Site Conditions	9
8.4.2 Required Pipe Combinations	9
8.4.3 Cold Water Supply Safety Components	9
8.4.4 Pressure Regulator Settings	9
8.4.5 Before Filling	9
8.4.6 Drainage and Re-circulation	9
8.5 Hot Water Temperature Probe	12
8.6 Solar Storage Tank - Temperature Probe	12
8.7 Connection to the Solar Unit	12
8.8 Sacrificial Anode	12
9. Temperature & Pressure Relief Valve Assembly	13
10. Warranty	15

2. SAFETY INSTRUCTIONS

General Information

Read this entire manual. Failure to follow all the guides, instructions and rules could cause personal injury or property damage. Improper installation, adjustment, alteration, service and use of this unit can result in serious injury.

This unit must be installed by a professional installer. The installation must comply with all national, state and local plumbing and electric codes. Proper installation is the responsibility of the installer. Failure to comply with the installation and operating instructions or improper use voids the warranty.

Save these instructions for future reference. Installer should leave these instructions with the consumer.

Service of the unit must be performed by a qualified service agency.

Never set the solar loop pressure greater than potable (domestic) water supply pressure. If the potable water pressure is too low, a booster pump may be needed to assure that it exceeds the required solar loop pressure.

If you have any questions regarding the installation, use or operation of this water heater, or if you need any additional installation manuals, please call our technical service line at 800-582-8423 (USA and Canada only). If you are calling from outside the USA or Canada, please call USA 413-247-3380 and we will refer you to a qualified Stiebel Eltron service representative in your area.

 **This is the safety alert symbol. It is used to alert you to potential personal injury hazard. Obey all safety messages that follow this symbol to avoid possible injury or death.**

Safety Instructions

 **WARNING: Never install any valves or shutoff devices in the piping between the collectors and the safety valve. The safety valve is actuated at 87 psi pressure.**

 **DANGER: Water temperatures over 125 °F can cause severe burns instantly or death from scalding. A hot water scalding potential exists if the thermostat on the unit is set too high. Households with small children, disabled or elderly persons may require that the thermostat be set at 120 °F or lower to prevent possible injury from hot water.**

 **DANGER: Setting the maximum tank temperature higher than 140 °F at the control unit is permissible only in conjunction with a thermostatically-controlled DHW mixing valve. Otherwise there can be a risk of scalding at the drawoff point.**

 **CAUTION: All sensor wiring should be rated for expected temperatures and must be protected from degradation and electrical interference.**

Solar Loop

Use only a mixture of 50% GRAS (food grade) Propylene Glycol and de-ionized water. (Heat Exchanger type SW, AWWA Fluid Class II - see MSDS for handling instructions.)

 **WARNING: Fluid may be discharged at high temperature and/or pressure. There can be a risk of scalding at the discharge point.**

No other fluid shall be used that would change the original classification of this system. Unauthorized alterations to this system could result in a hazardous condition.

3. OPERATION AND SERVICE



3.1 Start-up

The hydronic back-up boiler (see Figure 5) and solar storage tank (see Figures 4 & 5), constitute a functional unit. Hot water is generated throughout the year by the solar collectors (see Figure 4). Supplemental heat is provided by the back-up boiler when there is insufficient solar energy available (see Figure 5).

The entire heater and hot water system must be filled with water and have adequate air ventilation. Please refer to the solar collector's and the boiler's installation instructions.

4. MAINTENANCE AND CLEANING

Routine care and maintenance extends the life expectancy and operating safety of the hot water storage unit. The outer casing should be cleaned with a slightly damp cloth and commercially available neutral cleaning agent. This should be done on a regular basis.

4.1 Temperature / Pressure Relief Valve



WARNING: The T&P relief valve is designed to relieve built up pressure in the water heater. Fluid may be discharged at high temperature and/or pressure. Scalding hot water injuries can occur.

Notice: The water heater and T&P relief valve should be installed and piped in and to an area where water discharge and leaking will not cause property damage.

The proper function of the Temperature / Pressure ("T&P") relief valve is required to prevent damage to the hot water storage unit. The T&P valve needs to be open during cold-water addition. The water has to flow from the relief line at full stream.

4.2 Decalcification

With hard tap water, a deposit of scale will form on the inside of the storage unit. Based on professional experience, it is necessary to decalcify with commercially available solvents at timely intervals. Follow the manufacturers instructions for solvent use. The hot water storage unit needs to be emptied. The inspection cover must be removed and sediments on the tank bottom must be flushed.

4.3 Replacement of the Sacrificial Anode

Depending on the composition of the tap water, an inspection of the sacrificial anode (Pos. 1, Figure 1) at timely intervals is recommended. With heavy wear, an original equipment replacement anode must be installed to protect the inner container from corrosion. An inspection should be performed at least once a year.

5. FAILURES – CAUSES – CORRECTION

Failures	Causes	Correction
Inadequate water pressure	Shut-off valve is not completely open. Cold or hot water line is obstructed.	Open Shut-off valve. Clean or exchange pipes.
Hot water flow inadequate	Boiler temperature is set too low. Recommended 176 to 185 °F / 80 to 85 °C. Heat exchanger is calcified.	Set boiler to recommended temperature. Clean heat exchanger.
Hot water storage tank not being heated	Program selection at the heater control is not properly selected.	Select and set program per instructions.
Outlet quantity inadequate	Aerator at the extraction point blocked.	Unscrew aerator and clean.
Hot water supply exhausted too quickly	Flow rate too high. Recommended 2.6-3.9 gal./min. or 9.8-14.8 l/min.	Restrict spigot valve rate.

6. TECHNICAL SPECIFICATIONS

1 Components of the SBB S / SBB Plus

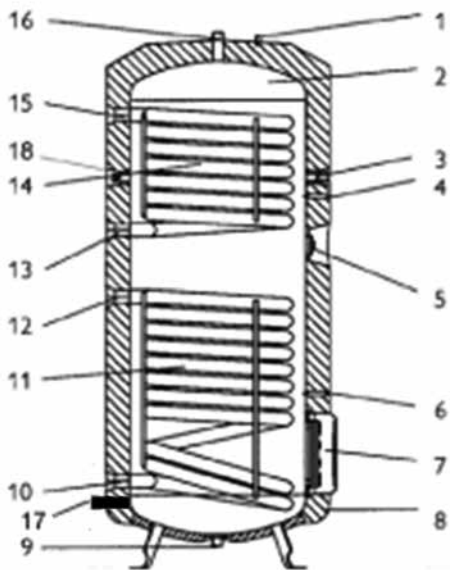

1. Sacrificial anode indicator
2. Glass lined steel tank
3. Thermometer well
4. Immersion sleeve for boiler temperature probe
5. Spare port
6. Immersion sleeve for solar temperature probe
7. Inspection port
8. Expanded polystyrene-thermal insulation
9. Cold water inlet (SBB 300 & 400 S/Plus)
10. Solar/main inlet
11. Solar/main heat exchanger
12. Solar/main return
13. Heat exchanger from boiler feed (SBB 300, 400, 600 Plus)
14. Upper heat exchanger (SBB 300, 400, 600 Plus)
15. Heat exchanger to boiler return (SBB 300, 400, 600 Plus)
16. Warm water outlet / T&P relief valve location
17. Cold water inlet (SBB 600 Plus)
18. Circulation port

6.1 Technical Data and Specifications

Model	SBB 300 S	SBB 400 S
Item No.	221219	221222
Contents		
Storage capacity	80.6 gal (305 l)	108.6 gal (411 l)
Volume of heat exchanger, top	N/A	N/A
Volume of heat exchanger, bottom	2.7 gal (10.1 l)	2.9 gal (11.3 l)
Pressure		
Working pressure	150 psi (10 bar)	150 psi (10 bar)
Tested to pressure	217 psi (15 bar)	217 psi (15 bar)
Max. pressure of boiler loop	150 psi (10 bar)	150 psi (10 bar)
Temperature		
Max. temperature lower loop	203 °F (95 °C)	203 °F (95 °C)
Max. temperature of upper loop	N/A	N/A
Heat exchanger		
Surface area heat exchanger top	N/A	N/A
Surface area heat exchanger bottom	2,325 sq in (1.5 m ²)	2,635 sq in (1.7 m ²)
Weights		
Tank weight empty	292 lb (133 kg)	371 lb (169 kg)
Tank weight full	988 lb (448 kg)	1,304 lb (591 kg)
Other		
Standby losses in 24 hours	6,500 Btu (1.9 kWh)	7,500 Btu (2.2 kWh)
Cold/hot water connection	for 1" copper pipe with adapters, provided with unit	

Model	SBB 300 PLUS	SBB 400 PLUS	SBB 600 PLUS
Item no.	187873	187874	187875
Contents			
Storage capacity	80.6 gal (305 l)	108.6 gal (411 l)	162.9 gal (617 l)
Volume of heat exchanger, top	1.9 gal (7.3 l)	2.2 gal (8.2 l)	2.5 gal (9.6 l)
Volume of heat exchanger, bottom	2.7 gal (10.1 l)	2.9 gal (11.3 l)	3.5 gal (13.2 l)
Pressure			
Working pressure	150 psi (10 bar)	150 psi (10 bar)	150 psi (10 bar)
Tested to pressure	217 psi (15 bar)	217 psi (15 bar)	217 psi (15 bar)
Max. pressure of boiler loop	150 psi (10 bar)	150 psi (10 bar)	150 psi (10 bar)
Temperature			
Max. temperature lower loop	203 °F (95 °C)	203 °F (95 °C)	203 °F (95 °C)
Max. temperature of upper loop	203 °F (95 °C)	203 °F (95 °C)	203 °F (95 °C)
Heat exchanger			
Surface area heat exchanger top	1705 sq in (1.1 m ²)	2,015 sq in (1.3 m ²)	2945 sq in (1.9 m ²)
Surface area heat exchanger bottom	2325 sq in (1.5 m ²)	2,635 sq in (1.7 m ²)	3875 sq in (2.5 m ²)
Weights			
Tank weight empty	339 lb (154 kg)	412 lb (187 kg)	544 lb (247 kg)
Tank weight full	988 lb (448 kg)	1,362 lb (618 kg)	1,955 lb (887 kg)
Other			
Standby losses in 24 hours	6,500 Btu (1.9 kWh)	7500 Btu (2.2 kWh)	10,000 Btu (2.9 kWh)
Cold/hot water connection	for 1" copper pipe with adapters, provided with unit		

2 Dimensions

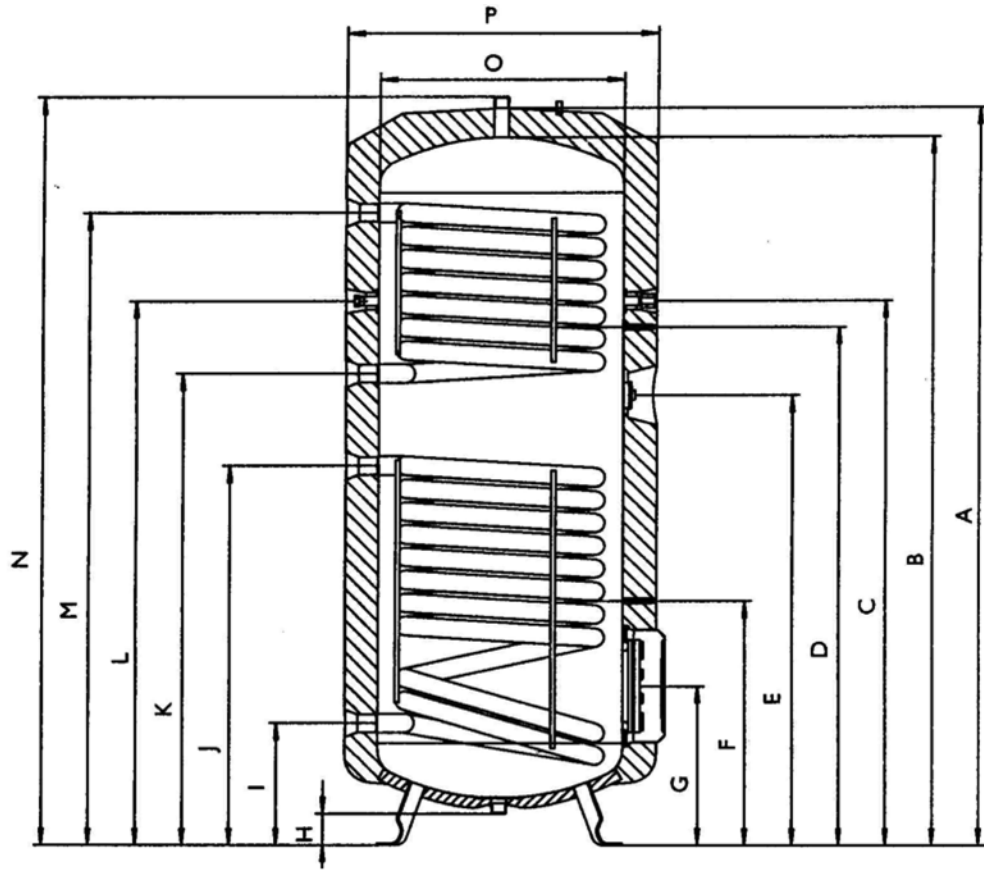

Type	SBB 300 Plus	SBB 400 Plus	SBB 600 Plus
A Height of unit w/insulation	66.1" (1679 mm)	72.7" (1848 mm)	68.3" (1735 mm)
B Height of unit without insulation	63.3" (1609 mm)	70.1" (1781 mm)	65.7" (1670 mm)
C Height of well for temp. sensor	46.4" (1179 mm mm)	48.7" (1238 mm)	46.9" (1192 mm)
D Height thermometer	41.1" (1045 mm)	43.0" (1093 mm)	41.5" (1055 mm)
E Height spare port	40.3" (1025 mm)	42.4" (1078 mm)	40.9" (1040 mm)
F Height of well for temp. sensor	21.9" (557 mm)	22.0" (560 mm)	23.4" (595 mm)
G Height inspection flange	14.4" (365 mm)	14.4" (367 mm)	15.9" (405 mm)
H Height cold water feed	2.9" (73 mm)	2.6" (65 mm)	2.0" (50 mm)
I Height solar cold feed	11.0" (280 mm)	11.1" (282 mm)	10.9" (277 mm)
J Height solar hot return	34.0" (865 mm)	34.1" (867 mm)	33.9" (862 mm)
K Height heater hot boiler return	38.4" (975 mm)	44.5" (1130 mm)	42.9" (1089 mm)
L Height circulation port	52.7" (1339 mm)	63.0" (1600 mm)	57.2" (1453 mm)
M Height cold boiler feed	52.7" (1339 mm)	63.0" (1600 mm)	57.2" (1453 mm)
N Overall height	67.08" (1704 mm)	73.74" (1873 mm)	69.29" (1760 mm)
O Width without thermal insulation	21.65" (550 mm)	23.62" (600 mm)	29.52" (750 mm)
P Width with thermal insulation	27.55" (700 mm)	29.52" (750 mm)	36.22" (920 mm)

7. INSTALLATION INSTRUCTIONS FOR THE PROFESSIONAL

7.1 General

Figure 1 is referenced for explanation of the following text.

7.1.1 Brief Description of the Appliance - Applications

The Stiebel Eltron Vertical Solar Storage tank SBB S / Plus, in combination with Stiebel Eltron's Solar Collector is an economical hot water generator.

The Stiebel Eltron Vertical Solar Storage tank SBB S / Plus, in combination with any hydronic boiler also functions as an efficient indirectly fired water heater.

7.1.2 Connections

All connections (cold and hot) are readily accessible and allow for easy installation.

7.2 Delivery Configuration

The hot water storage tank SBB S / Plus is wrapped in plastic and is delivered on a one-way pallet. The storage tank has foam insulation, a ABS outer casing and ABS cover.

Equipment:

- Storage unit with two welded steel plain-ended pipe heat exchangers
- Hot water corrosion protection with special enamel coating
- Maximum operation pressure
Hot water 150 psi (10 bar)
Heated water 150 psi (10 bar)
- Three immersion sleeves for housing of temperature probe and thermometer
- Magnesium Safety Anode
- Circulation Socket
- Attached Flange inspection cover (SBB models)
- PU Foam insulation 2.95 in. (70 mm.) thick
- ABS outer casing with zipper in protective pouch
- ABS Cover and Flange cover

Only for SBB 600 Plus:

- Removable polyurethane-side panels with fastening strap and locking parts

7.3 Tasks to be performed by Installer

An approved technician should perform the setup, installation and initial start-up following these instructions.

7.4 Regulations and Standards



WARNING: THIS PRODUCT MUST BE INSTALLED ACCORDING TO ALL NATIONAL AND LOCAL PLUMBING AND ELECTRICAL CODES. IT MUST BE INSTALLED BY A LICENSED PLUMBER AND ELECTRICIAN.

Refer to: all local construction, fire-code and trade control regulations.

3

Figure 3: SBB 600 Plus Solar Tank with insulation

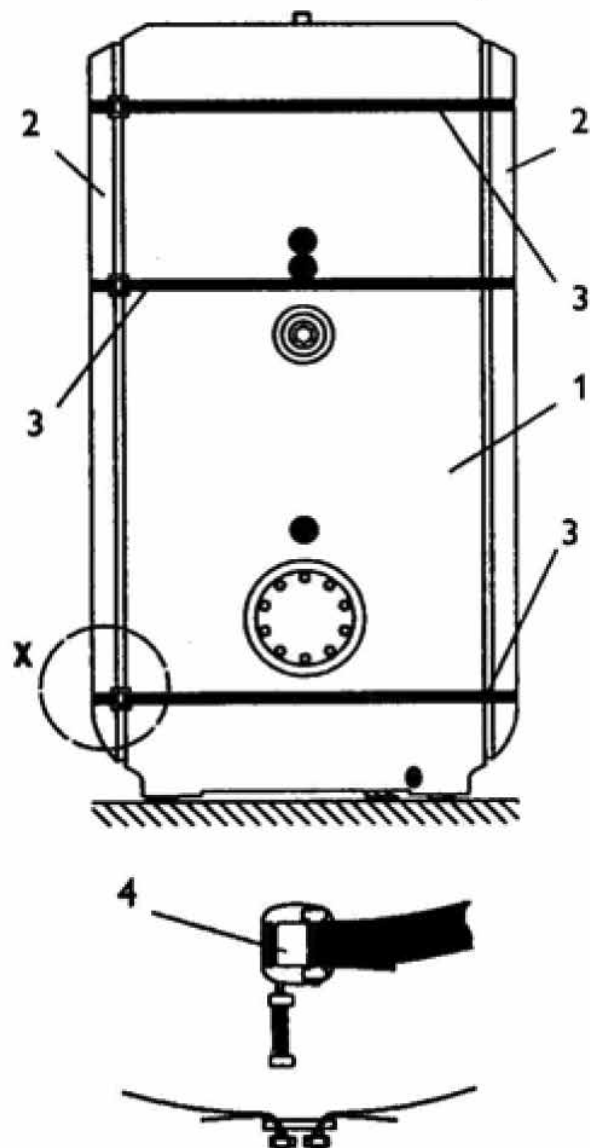

- 1 Solar tank
- 2 PU side panel
- 3 Fastening strap
- 4 Locking part

8. SET-UP AND INSTALLATION

8.1 Set-up



NOTICE: THE UNIT SHOULD BE LOCATED IN AN AREA WHERE WATER LEAKAGE FROM THE UNIT OR ANY CONNECTIONS WILL NOT RESULT IN DAMAGE TO THE AREA SURROUNDING THE UNIT.

DANGER: THE UNIT MUST NOT BE LOCATED NEAR FLAMMABLE LIQUID SUCH AS GASOLINE, ADHESIVES, SOLVENTS, PAINT THINNERS, BUTANE, LIQUIFIED PROPANE, ETC. AS THE CONTROLS OF THIS APPLIANCE COULD IGNITE VAPORS CAUSING AN EXPLOSION.

Inspect the packaging for damage and remove packaging at the installation site. Verify presence of six brass thread to sweat fittings. The installation site must be structurally capable of supporting the weight of the tank when filled. The location has to be above freezing. The water drainage pipe must be freeze proof.

8.2 Connection

Refer to Figure 1 and Figure 2.

8.3 Heater Installation

The installation of the hydronic loop is shown in Figures 4 & 5. The circuit must include a Temperature / Pressure Relief Valve, and air-vent, a check valve, and an expansion tank.

8.4 Hot Water Installation

8.4.1 Local Site Conditions

Prior to installation check that the local conditions are compatible with the appliance design, especially that the maximum working excess pressure of 150 psi (10 bar.) is not exceeded.

8.4.2 Required Pipe Combinations

A steel or a copper pipe with insulation can be used for the hot water connectors. Copper pipe with insulation is especially suitable due to its low heat loss.

Required combinations:

Cold water pipeline	Hot water pipeline
Copper pipe	Copper pipe
Steel pipe	Steel or copper pipe
Plastic pipe	Steel or copper pipe

8.4.3 Cold Water Supply Safety Components

All safety components must be installed into the cold water supply (Fill & drain valve, Check valve, isolating ball valve & pressure regulator, see Figures 4 & 5). The order of the individual fittings must be in accordance to local regulations.

8.4.4 Pressure Regulator Settings

The pressure regulator has to be set to 150 psi (10 bar). It can only be installed into the cold water supply. The supply has to be thoroughly inspected prior to installation. Installation of dirt filters or any other narrowing of the supply line to the pressure relief valve is forbidden.

The temperature & pressure relief valve has to be easily accessible. Expansion water generated during the heating has to flow visibly to a drain. The drainage pipe must be large enough to accommodate water drainage with a fully opened T & P valve. The drainage pipe must be protected from freezing and must not lead outdoors.

The pressure regulator (Figures 4 & 5) has to be set so no water drips from the T & P valve.

Heavy dripping of the T & P valve can be caused by dirt in the valve seat or water pressure. Water pressure needs to be regulated below 150 psi.

8.4.5 Before Filling

Prior to filling all screws must be tight.

8.4.6 Drainage and Re-circulation

Drainage of the hot water tank is via the fill & drain valve (Figures 4 & 5).

A re-circulator can be attached to a separate socket across the thermometer. Drill the outer casing with a hole saw \varnothing 50 where marked and remove insulation from the socket in that area.

For energy conservation, use of a circulator is not recommended.

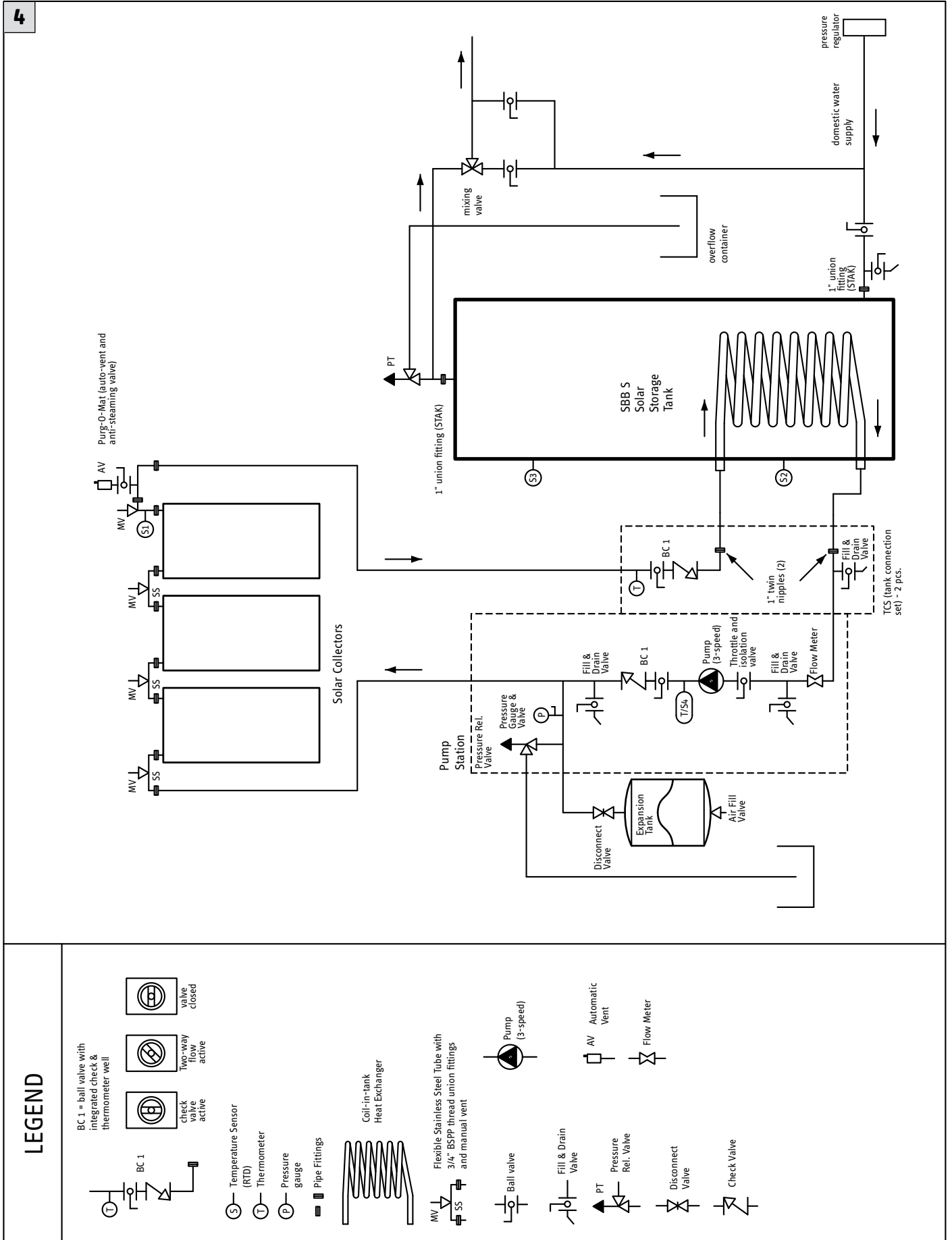
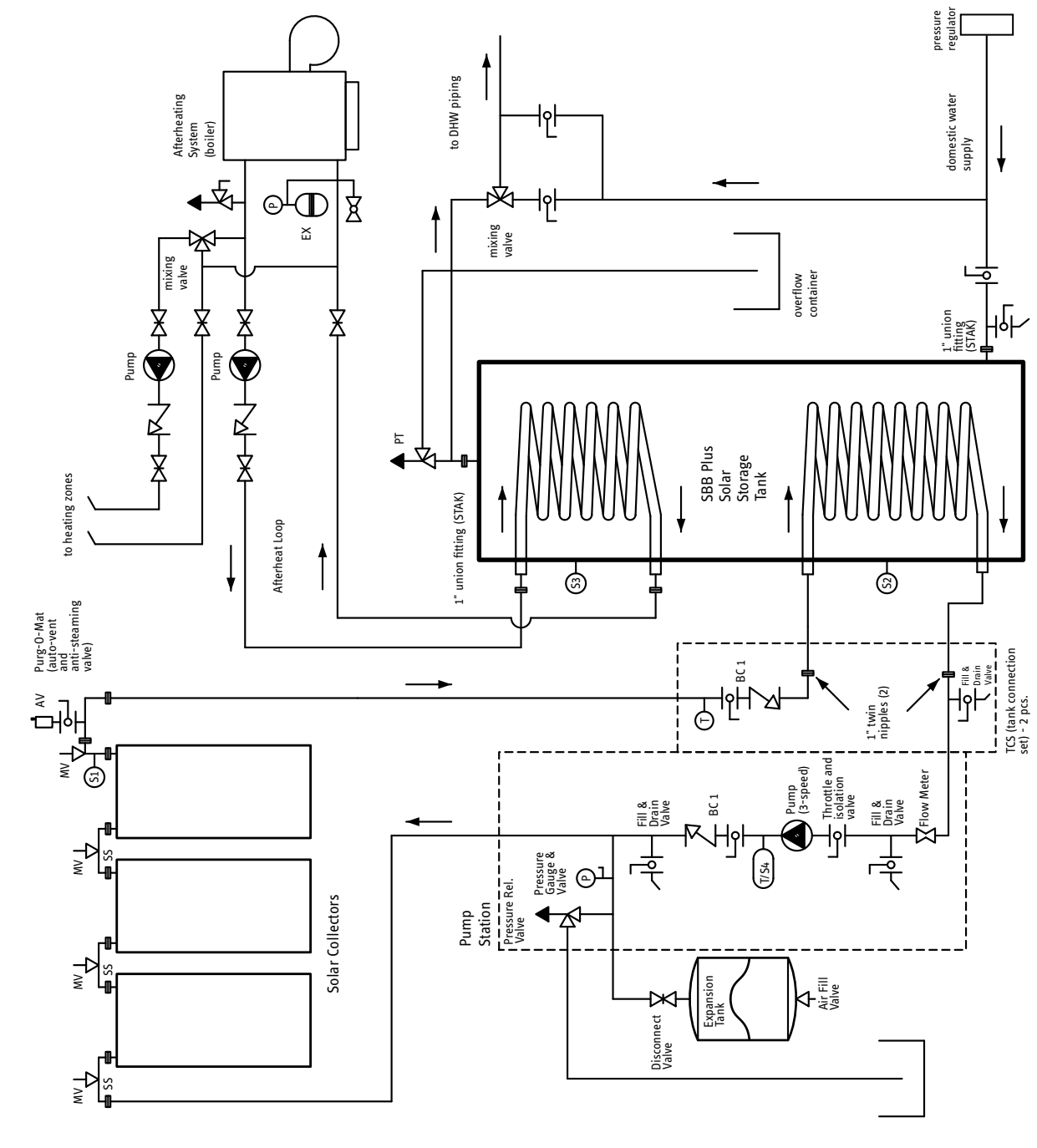

Figure 4: Installation / system diagram for SBB S solar storage tank without hydronic back-up

5



LEGEND











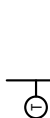



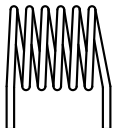

-  BC 1 = ball valve with integrated check & thermometer well
-  Check valve active
-  Two-way flow active
-  valve closed
-  Temperature Sensor (RTD)
-  Thermometer
-  Pressure gauge
-  Pipe Fittings
-  Coil-in-tank Heat Exchanger
-  Ball valve
-  Fill & Drain Valve
-  Pressure Rel. Valve
-  Disconnect Valve
-  Check Valve
-  Pump (3-speed)
-  AV Automatic Vent
-  Flow Meter

Figure 5: Installation / system diagram for SBB Plus solar storage tank with hydronic back-up

8.5 Hot water temperature probe

The hot water temperature probe is to be installed into the upper immersion sleeve (Pos. 3, Figure 1).

8.6 Solar Storage Tank – Temperature Probe

The solar storage tank temperature probe to lower immersion sleeve of the hot water storage tank (Pos. 6, Figure 1). The temperature probe must be completely inserted into the probe sleeve.

6 Figure 5: Temperature probe assembly

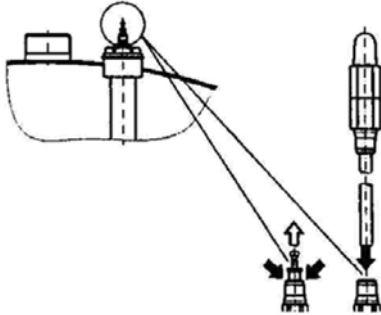

7 Figure 6: Sacrificial anode indicator

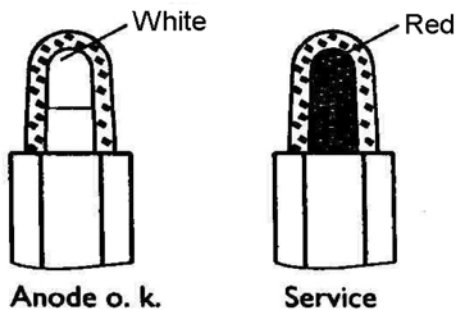

8.7 Connection to the Solar Unit

The installation of the solar loop is shown in Figures 4 & 5. The solar loop must include temp/pressure relief, an air-vent, a check valve and an expansion tank. Refer to the separate operation and installation instructions for the SOL 25 Plus flat plate solar collector.

IMPORTANT NOTICE: Test operation after installation. Start up must follow the approval of the installer (refer to section 3. operation and service).

8.8 Sacrificial anode (spare part)

If a sacrificial anode is installed into the SBB S or SBB Plus storage tank, the following must be observed:

Installation – sacrificial anode

- Pull out the red shut-off plug while simultaneously depressing the pressure ring, (see Figure 7).
- Push in the open pipe end of the indicator element until dead-stop.
- Attach the sticker “Note Signal Anode” to a highly visible spot on the insulation.

NOTICE: When the storage tank is not operated with a signal display, the red plug must remain in the anode.

Function – Sacrificial indicator

- After consumption of the anode, humidity escapes through the hollow anode core to the signal cartridge and causes a color change there (see Figure 7)
- When the cartridge turns red contact the installer so he can check the anode and if needed replace it.

Routine maintenance improves operating safety and life expectancy of the SBB S and SBB Plus solar hot water storage tanks.

9. TEMPERATURE & PRESSURE RELIEF VALVE ASSEMBLY

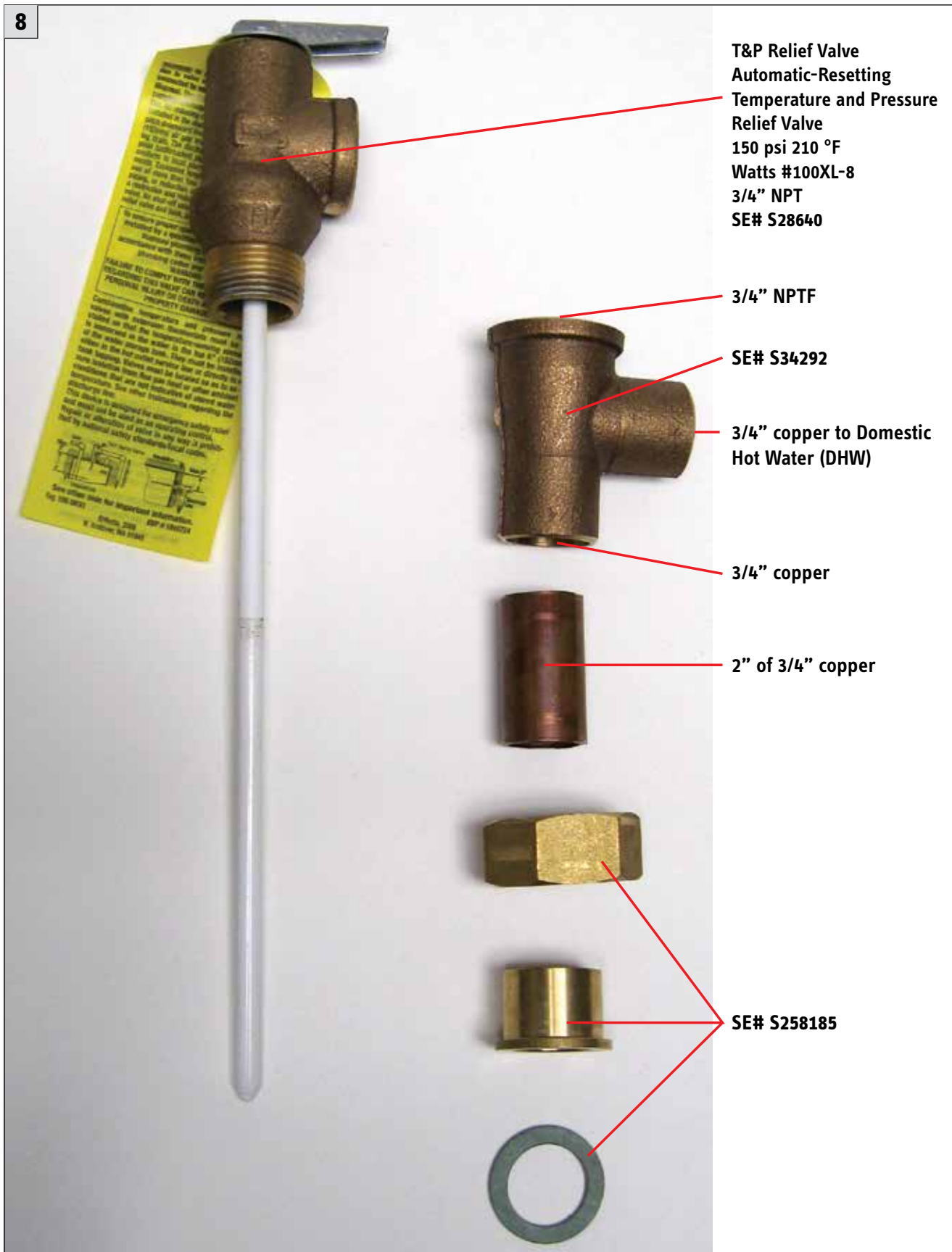

Figure 8: Exploded view of T&P relief valve assembly including part numbers

Mounted to top of SBB tank

T&P Relief Valve
 Automatic-Resetting
 Temperature and Pressure
 Relief Valve
 150 psi 210 °F
 Watts #100XL-8
 3/4" NPT
 SE# S28640

Pressure relief safety vent pipe (3/4" NPTF)

SE# S34292

3/4" copper to Domestic Hot Water (DHW)

2" of 3/4" copper

SE# S258185



Complete assembly on SBB tank.

Figure 9: Assembled view of T&P relief valve assembly including part numbers

LIMITED WARRANTY

Subject to the terms and conditions set forth in this limited lifetime warranty, Stiebel Eltron, Inc. (the "Manufacturer") hereby warrants to the original purchaser (the "Owner") that each storage tank (the "Tank") shall be free from defects in the Manufacturer's materials or workmanship for a period of:

1. (10 Years) from the date of purchase for single, two-, and three-family residential installations
2. (5 Years) from the date of purchase for all other installations
3. (Excluded) sacrificial or electronic anode

As Owner's sole and exclusive remedy for the above warranty, Manufacturer shall, at the Manufacturer's discretion, either factory repair or replace the defective Tank with a replacement unit or part(s) with comparable operating features. Manufacturer's maximum liability under all circumstances shall be limited to the Owner's purchase price for the Tank.

This limited warranty shall be the exclusive warranty made by the Manufacturer and is made in lieu of all other warranties, express or implied, whether written or oral, including, but not limited to warranties of merchantability and fitness for a particular purpose. Manufacturer shall not be liable for incidental, consequential or contingent damages or expenses arising directly or indirectly from any defect in the Tank or the use of the Tank. Manufacturer shall not be liable for any water damage or other damage to property of Owner arising, directly or indirectly, from any defect in the Tank or the use of the Tank. Manufacturer alone is authorized to make all warranties on Manufacturer's behalf and no statement, warranty or guarantee made by any other party shall be binding on Manufacturer.

Manufacturer shall not be liable for any damage whatsoever relating to or caused by:

1. any misuse or neglect of the Tank, any accident to the Tank, any alteration of the Tank, or any other unintended use;
2. acts of God and circumstances over which Manufacturer has no control;
3. installation of the Tank other than as directed by Manufacturer and other than in accordance with applicable building codes;
4. improper installation and/or improper materials used by any installer and not relating to defects in parts or workmanship of Manufacturer;
5. failure to maintain the Tank or to operate the Tank in accordance with the Manufacturer's specifications;
6. failed components not originally installed by the Manufacturer as a part of the unit at the time of sale;
7. exposure to freezing conditions;

8. exposure to harmful chemicals, contaminated water, corrosive fluids or atmosphere, liquids harmful to steel tubing including improperly applied or maintained heat transfer fluids.
9. utilizing the tank as an open loop heat exchanger, e.g., do not use in drainback systems or continually pass fresh potable water through the units internal heat exchanger.
10. installing the Tank in a closed system without a properly sized and installed thermal expansion tank;
11. operating the Tank without the factory installed sacrificial anode;
12. operating the Tank under fluctuating or excessive water pressure or in the event the Tank is supplied with non-potable water for any duration;
13. operating the Tank when it is empty or partially full of potable water;
14. Installing and operating the Tank outdoors;
15. operating the Tank at temperatures higher than recommended by Manufacturer;
16. (SB E models) replacing the electric heating element with a unit not manufactured by Stiebel Eltron or greater in power than the originally installed element;
17. (SB E models) connecting the Tank to improper voltage or service;

Should owner wish to return the Tank to manufacturer for repair or replacement under this warranty, Owner must first secure written authorization from Manufacturer. Owner shall demonstrate proof of purchase, including a purchase date, and shall be responsible for all removal and transportation costs. If Owner cannot demonstrate a purchase date this warranty shall be limited to the period beginning from the date of manufacture stamped on the Tank. Manufacturer reserves the right to deny warranty coverage upon Manufacturer's examination of the Tank. This warranty is restricted to the Owner and cannot be assigned.

Some States and Provinces do not allow the exclusion or limitation of certain warranties. In such cases, the limitations set forth herein may not apply to the Owner. In such cases this warranty shall be limited to the shortest period and lowest damage amounts allowed by law. This warranty gives you specific legal rights and you may also have other rights which vary from State to State or Province to Province.

Owner shall be responsible for all labor and other charges incurred in the removal or repair of the Tank in the field. Please also note that the Tank must be installed in such a manner that if any leak does occur, the flow of water from any leak will not damage the area in which it is installed.

This Warranty is valid for all purchases on or after June 15, 2019.

This Warranty is valid for U.S.A. & Canada only. Warranties may vary by country. Please consult your local Stiebel Eltron Representative for the Warranty for your country.

STIEBEL ELTRON

17 West Street

West Hatfield, MA 01088

TOLL FREE 800.582.8423

PHONE 413.247.3380

FAX 413.247.3369

info@stiebel-eltron-usa.com

www.stiebel-eltron-usa.com

STIEBEL ELTRON, Inc.
17 West Street | West Hatfield MA 01088
Tel. 413-247-3380 | Fax 413-247-3369
info@stiebel-eltron-usa.com
www.stiebel-eltron-usa.com

STIEBEL ELTRON