

### Features

- Two-piece toilet.
- Elongated bowl offers added room and comfort.
- Skirted trapway simplifies cleaning.
- Revolution 360 swirl flushing technology generates a forceful swirling motion to keep the bowl cleaner, longer.
- Comfort Height feature offers chair-height seating that makes sitting down and standing up easier for most adults.
- 1.28 gallons per flush (gpf).
- Standard left-hand Polished Chrome trip lever included.
- 2-1/8-inch fully glazed trapway.
- Patented ReadyLock™ installation system is a simple solution for skirted toilets that saves time, hassle, and eliminates the need to drill into the floor for a standard 12-inch rough-in.
- CleanCoat™ technology inhibits the growth of water scale and mineral stains for improved ease of cleaning.
- Combination consists of the K-4144 bowl and K-4143 tank.

### Technology

- Single-flush gravity uses the force of gravity and a precision-engineered tank, bowl, and trapway to create a strong siphon during flushing.
- AquaPiston® canister allows water to flow out of the tank from all sides (360 degrees), increasing the power and effectiveness of the flush.
- Flush valve's 3:2 ratio harnesses the natural force of gravity and optimizes flush performance.
- Durable canister design has 90% less exposed seal material than a 3-inch flapper, for leak-free performance.
- Light-touch canister flush requires a lower actuation force than a flapper.

### Installation

- Standard 12-inch rough-in.
- 10-inch and 14-inch rough-in kits are also available.
- Seat and supply line not included.
- ReadyLock installation system offers easy, intuitive installation with no need to drill holes in floor for standard 12-inch rough-ins.

### Water Conservation & Rebates

- WaterSense toilets meet strict EPA flushing guidelines, including using at least 20 percent less water than 1.6-gallon toilets.
- Eligible for consumer rebates in some municipalities.

### Recommended Products/Accessories

- K-4008 Reveal® Quiet-Close™ Elongated Toilet Seat
- K-4108 C3®-230 Elongated Cleansing Toilet Seat
- K-7637 Angle Supply with Stop (single)
- K-5383 10" Rough-in Full Skirt Trap and Attachment System
- K-5381 14" Rough-in Full Skirt Trap and Attachment System



**ADA** **CSA B651** **OBC**

### Codes/Standards







ASME A112.19.2/CSA B45.1  
DOE - Energy Policy Act 1992  
EPA WaterSense®  
California Energy Commission (CEC)  
ADA  
ICC/ANSI A117.1  
CSA B651  
OBC

### KOHLER® One-Year Limited Warranty

See website for detailed warranty information.

### Available Colors/Finishes

*Color tiles intended for reference only.*

| Color  | Code | Description  |
|--|------|--------------|
|  | 0    | White        |
|  | 96   | Biscuit      |
|  | NY   | Dune         |
|  | 95   | Ice™ Grey    |
|  | G9   | Sandbar      |
|  | 7    | Black Black™ |

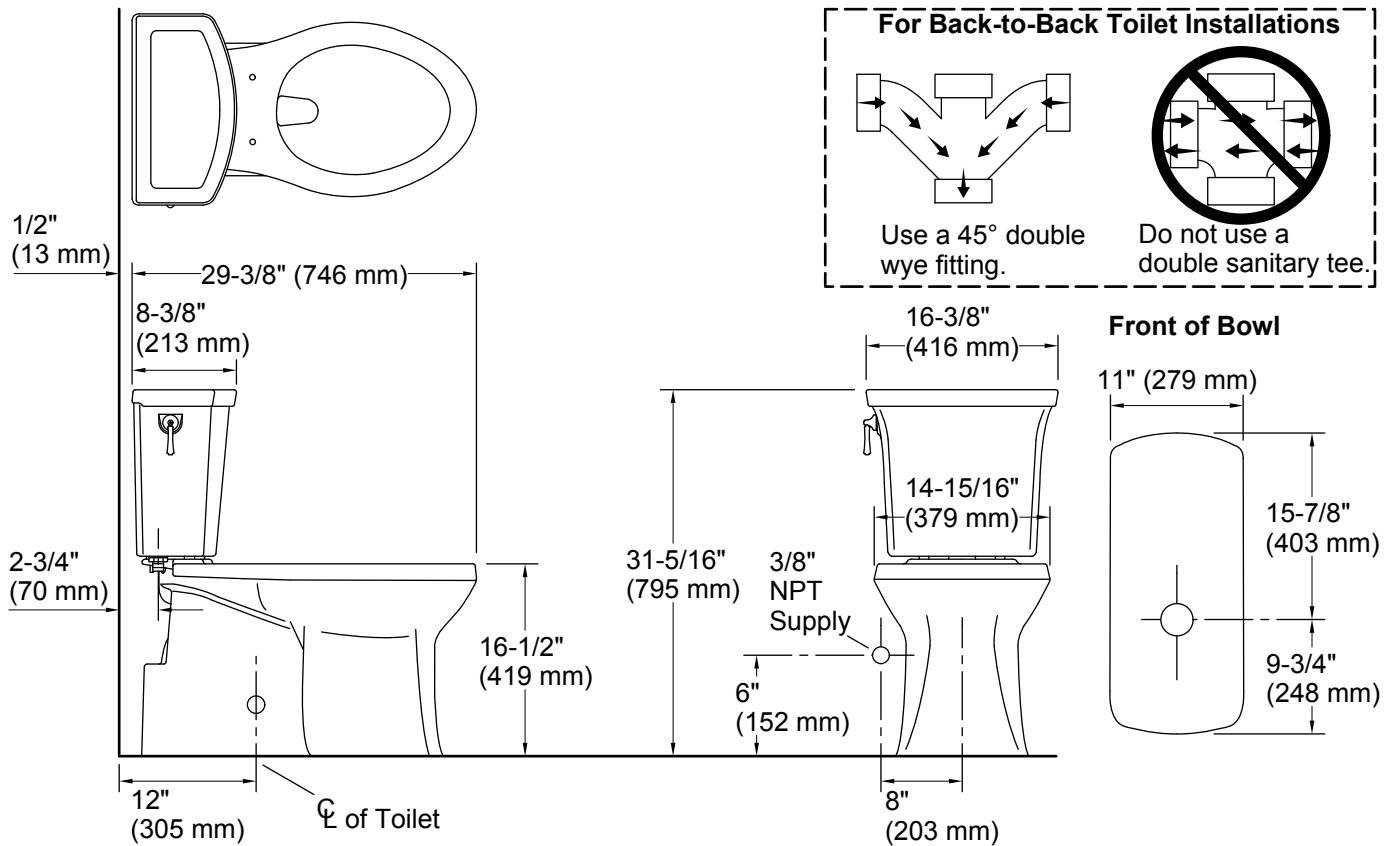

### Technical Information

All product dimensions are nominal.

|                       |                                   |
|-----------------------|-----------------------------------|
| Toilet type:          | Two-piece, Floor-mount            |
| Waste Outlet:         | Floor                             |
| Bowl shape:           | Elongated                         |
| Flush type:           | Gravity siphon jet                |
| Trap passageway:      | 2-1/8" (54 mm)                    |
| Water Consumption     |                                   |
| Full:                 | 1.28 gpf (4.8 lpf)                |
| Water surface size:   | 9-3/4" x 7-1/4" (248 mm x 184 mm) |
| Rim to water surface: | 6-1/4" (159 mm)                   |
| Rough-in:             | 12" (305 mm)                      |

### Fixture Supply Requirements

|                      |                    |
|----------------------|--------------------|
| Min static pressure: | 15 psi (103.4 kPa) |
| Max static pressure: | 80 psi (551.6 kPa) |

### Notes

Install this product according to the installation instructions.

For back-to-back toilet installations: Use only a 45° double wye fitting.

ADA, OBC, CSA B651 compliant when installed to the specific requirements of these regulations.

Plumbing codes may require elongated toilets and elongated, open-front seats in public bathrooms.

Accessibility standards may require controls to be located on the open side of the toilet.