

### Features

- Single-speed whirlpool offers performance and value, with 8 fully adjustable jets.
- Hydromassage flow and direction can be controlled at each jet.
- Comfort Depth® design offers a convenient 19-inch step-over height while retaining the same depth as a standard 21-inch bath.
- Molded lumbar support offers extra comfort while bathing.
- Slotted overflow allows for deep soaking.
- Integral flange helps prevent water from seeping behind wall and simplifies alcove installation.
- Right-hand drain.
- Coordinates with other products in the Archer collection.

### Material

- Acrylic

### Hydrotherapy

- Whirlpool

### Installation

- Three-wall alcove.

### Additional Hydrotherapy Options

- Soaking Bath - K-1946-R
- Soaking Bath + Bask heated surface - K-1946-RW
- BubbleMassage air bath - K-1947-GRF
- BubbleMassage air bath + Bask heated surface - K-1947-GRW
- VibrAcoustic - K-1947-VBR
- VibrAcoustic + Bask heated surface - K-1947-VBRW
- Whirlpool - K-1947-R
- Whirlpool + heater - K-1947-RH
- Whirlpool + Bask heated surface - K-1947-RW
- Whirlpool + BubbleMassage air bath - K-1947-XHGR

### Required Products/Accessories

K-7271 Brass Slotted Overflow Bath Drain

or

K-7272 PVC Slotted Overflow Bath Drain

### Recommended Products/Accessories

K-24916 Wireless Music Kit



ADA

### Codes/Standards











ASME A112.19.7/CSA B45.10  
CSA B45.5/IAPMO Z124  
UL 1795  
CSA C22.2 No. 218.2  
ADA  
ICC/ANSI A117.1

**KOHLER® Plastic Baths and Receptors  
Lifetime Limited Warranty  
KOHLER® Hydrotherapy Components  
Five-Year Limited Warranty**

See website for detailed warranty information.

### Available Colors/Finishes

*Color tiles intended for reference only.*

Color	Code	Description
	0	White
	96	Biscuit
	47	Almond
	NY	Dune
	95	Ice™ Grey
	G9	Sandbar
	33	Mexican Sand™
	K4	Cashmere
	58	Thunder™ Grey
	7	Black Black™

No change in measurements if connected with drain illustrated. (K-7272)

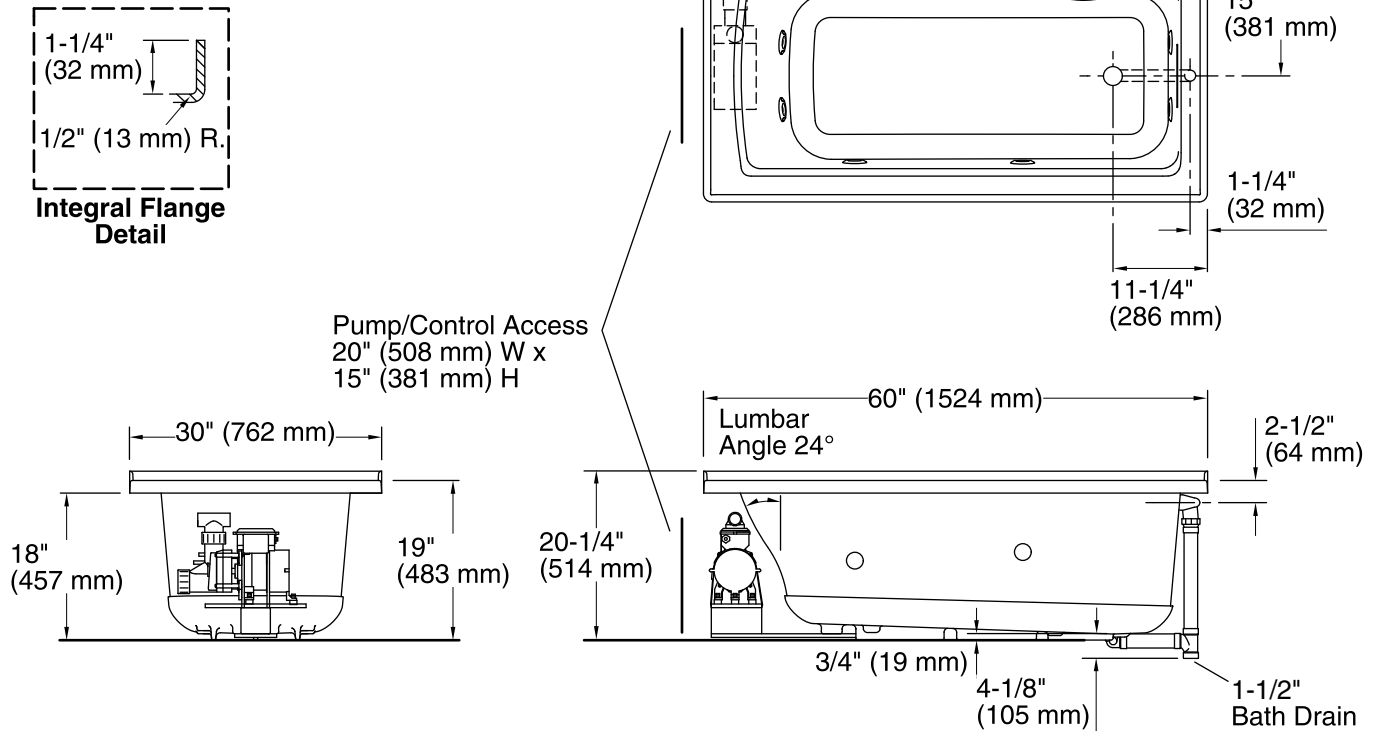

### Required Electrical Service

One dedicated circuit required, protected with Class A Ground-Fault Circuit-Interrupter (GFCI). Outside North America, this device may be known as a Residual Current Device (RCD).

Pump: 120 V, 15 A, 60 Hz

### Technical Information

All product dimensions are nominal.

Installation: Three-wall alcove  
 Drain location: Right  
 Basin area, bottom: 45-1/8" x 19-11/16" (1146 mm x 500 mm)  
 Basin area, top: 52-1/8" x 22-1/16" (1324 mm x 560 mm)  
 Weight: 98 lbs (44.5 kg)  
 Minimum floor load: 48 lbs/ft<sup>2</sup> (234.4 kg/m<sup>2</sup>)  
 Water depth: 15-1/8" (384 mm)  
 Water capacity: 57 gal (215.8 L)  
 Electrical component rating: Pump: 120 V, 7 A, 60 Hz  
 Pump speed: Single  
 Minimum flat for door: 2" (51 mm)

### Notes

Measure your actual product for rough-in details. Install this product according to the installation instructions.

The hot water supply should be 70% of the capacity of the bath or greater. Installations will vary.

ADA compliant when installed to the specific requirements of these regulations.