

Features

- Bask® heated surface creates spa-like relaxation with soothing warmth on your back and neck.
- Three heat settings allow you to customize the surface temperature.
- Comfort Depth® design offers a convenient 19-inch step-over height while retaining the same depth as a standard 21-inch bath.
- Molded lumbar support offers extra comfort while bathing.
- Slotted overflow allows for deep soaking.
- Textured bottom surface.
- Reversible drain.
- Coordinates with other products in the Archer collection.

Material

- Acrylic

Installation

- Drop-in

Additional Hydrotherapy Options

- Soaking Bath - K-1946-0
- Soaking Bath + Bask heated surface - K-1946-W1
- BubbleMassage air bath - K-1947-G
- BubbleMassage air bath + Bask heated surface - K-1947-GW
- VibrAcoustic - K-1947-VB
- VibrAcoustic + Bask heated surface - K-1947-VBW
- Whirlpool - K-1947-0
- Whirlpool + heater - K-1947-H
- Whirlpool + Bask heated surface - K-1947-W1
- Whirlpool + BubbleMassage air bath - K-1947-XHG

Required Products/Accessories

K-7271 Brass Slotted Overflow Bath Drain

or

K-7272 PVC Slotted Overflow Bath Drain

Recommended Products/Accessories

K-24916 Wireless Music Kit



ADA

Codes/Standards









CSA B45.5/IAPMO Z124
UL 1795
ADA
ICC/ANSI A117.1

**KOHLER® Plastic Baths and Receptors
Lifetime Limited Warranty
KOHLER® Hydrotherapy Components
Five-Year Limited Warranty**

See website for detailed warranty information.

Available Colors/Finishes

Color tiles intended for reference only.

Color	Code	Description
	0	White
	96	Biscuit
	47	Almond
	NY	Dune
	95	Ice™ Grey
	G9	Sandbar
	K4	Cashmere
	58	Thunder™ Grey
	7	Black Black™

No change in measurements if connected with drain illustrated. (K-7272)

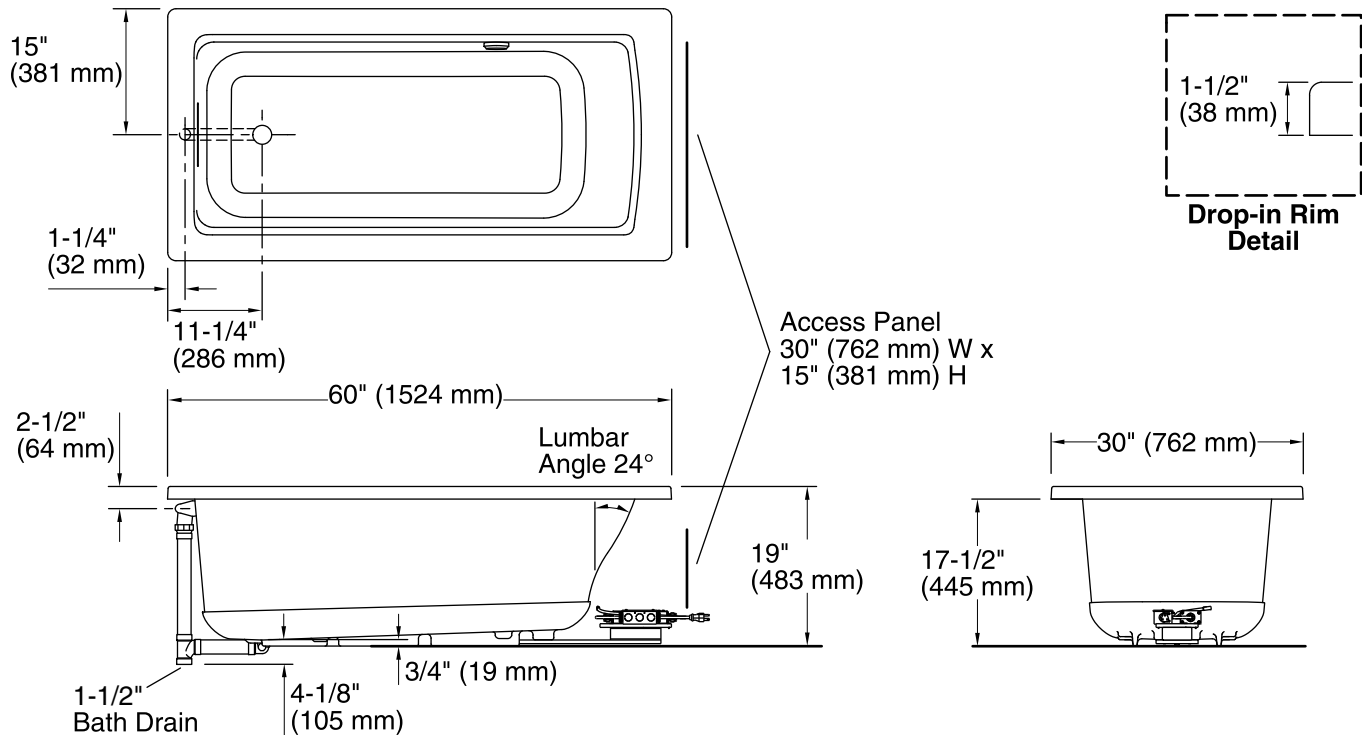

Required Electrical Service

One circuit required, protected with Class A Ground-Fault Circuit-Interrupter (GFCI). Outside North America, this device may be known as a Residual Current Device (RCD).

Heated Surface: 120 V, 15 A, 60 Hz

Technical Information

All product dimensions are nominal.

Installation:	Drop-in
Drain location:	End
Basin area, bottom:	45-1/8" x 19-11/16" (1146 mm x 500 mm)
Basin area, top:	52-1/8" x 22-1/16" (1324 mm x 560 mm)
Weight:	68 lbs (30.8 kg)
Minimum floor load:	45.5 lbs/ft ² (222.2 kg/m ²)
Water depth:	15-1/8" (384 mm)
Water capacity:	57 gal (215.8 L)
Cutout:	Drop-in, 85-1/2" x 20-1/2" (2172 mm x 521 mm)
Electrical component rating:	Heated Surface: 120 V, 0.5 A, 60 Hz, 65 W
Minimum flat for door:	2" (51 mm)

Notes

Measure your actual product for rough-in details. Install this product according to the installation instructions.

The hot water supply should be 70% of the capacity of the bath or greater. Installations will vary.

Provide one grounded electrical outlet within 24" (610 mm) of each component.

ADA compliant when installed to the specific requirements of these regulations.