

Brass Ball Valve



2 Piece • Full Port • Male x Female Connection • 600 WOG



JF-100TFM

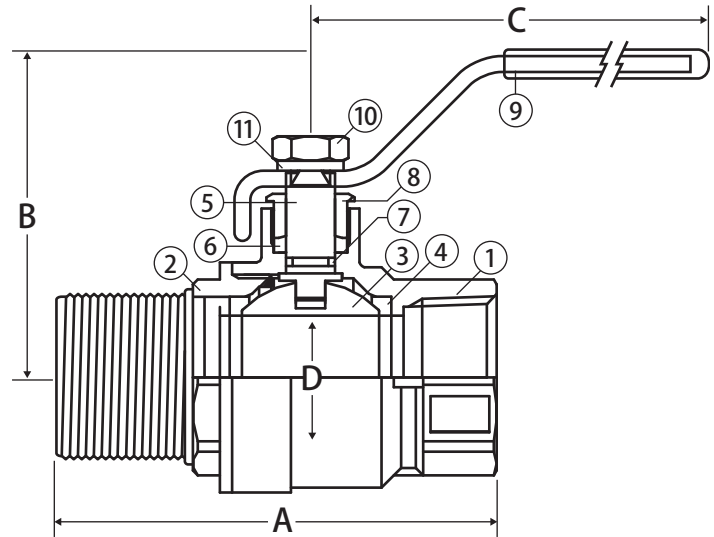

Features

- Gland follower and single o-ring stem design
- Blow-out proof stem
- 100% leak tested

Approvals



- UL Listed up to 175 PSI
 - MHKZ - Manual valves
 - YRPV - Gas shut-off valves
- MSS SP-110
- ANSI B1.20.1
- FM Approval (1/4" - 2")

Valve Seat Rating 600 WOG - 150 WSP

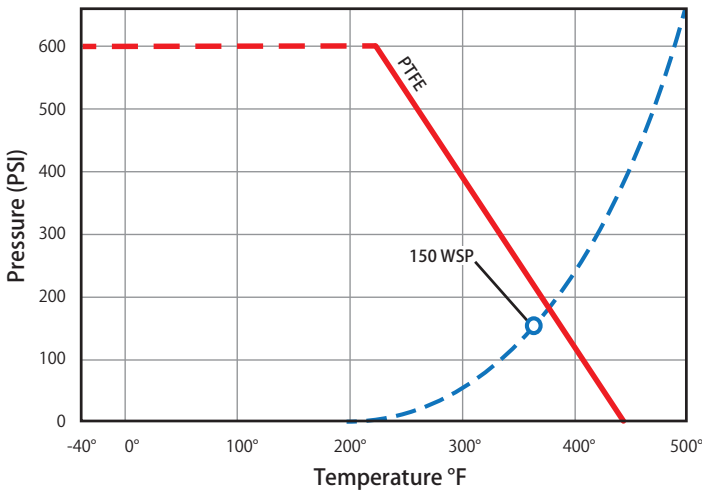

Material Specifications

No.	Part	Materials
1	Body	Brass - C37700
2	End Connection	Brass - C37700
3	Ball	Chrome Plated Brass - C37700
4	Seat (2)	PTFE
5	Stem	Brass - C37700
6	Packing	PTFE
7	Stem O-ring	Buna-N
8	Packing Gland	Brass - C37700
9	Handle	Steel - Chrome Plated
10	Handle Nut	Steel - Chrome Plated
11	Lock Washer	Steel - Chrome Plated

Dimensions

Part No.	Size	A	B	C	D
100-131	1/4"	2.05	1.69	3.35	0.39
100-132	3/8"	2.05	1.69	3.35	0.39
100-133	1/2"	2.50	1.81	3.35	0.59
100-134	3/4"	2.83	2.36	4.29	0.75
100-135	1"	3.27	2.52	4.29	0.98

WARNING: This product can expose you to chemicals including lead, which is known to the State of California to cause cancer, and lead, which is known to the State of California to cause birth defects or other reproductive harm. For more information go to www.P65Warnings.ca.gov.