

# JASON<sup>®</sup>

HYDROTHERAPY

8328 MacArthur Dr. • North Little Rock, AR 72118  
 501.771.4477 • Fax: 501.771.2333  
 Customer Service: 800.255.5766  
 www.jasoninternational.com

## Designer Collection Specifications

# AN553P

### AirMasseur<sup>®</sup> -Soaking

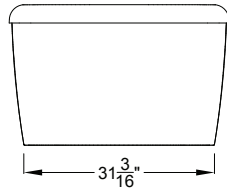
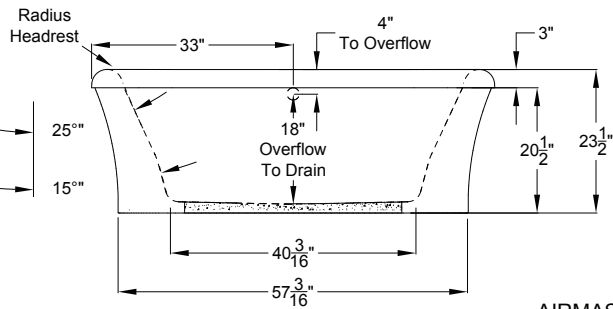
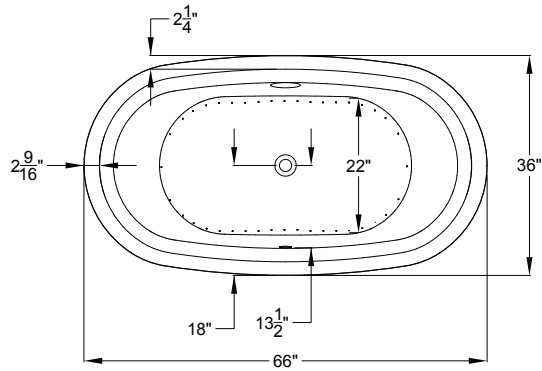

Shown with optional Ring Base

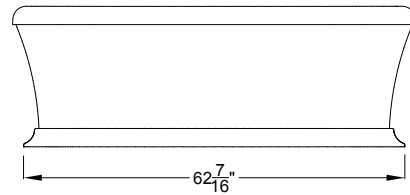
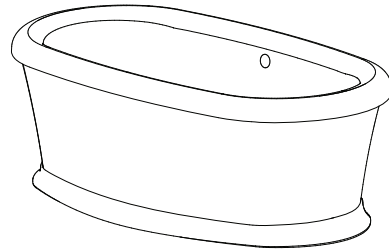

AIRMASSEUR BLOWER MUST BE REMOTE MOUNTED OR INSTALLED IN AN AEC EQUIPMENT CABINET.

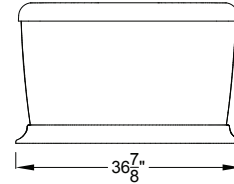



Patents received or pending.

Note: Dimensional Tolerances: ±1/4"

<b>Drop-in-Hole Size:</b>	N/A
<b>Operating Capacity:</b>	44 Gal.
<b>Overflow Capacity:</b>	74 Gal.
<b>Floor Loading / sq.ft.:</b>	57.1/53.9 lbs.
<b>Carton Weight:</b>	185/147 lbs.
<b>Cube:</b>	36.6 ft. <sup>3</sup>

**Construction:** Fiberglass reinforced acrylic bath with Level Form™ full-support base.

*We provide products listed with Intertek ETL SEMKO (Edison Testing Laboratories) U.S. and Canadian and with International Association of Plumbing and Mechanical Officials (IAPMO). Consult factory with your listing requirements.*

<b>Standard</b>		A 120V system that includes a 1HP, variable speed blower with integral heater; automatic purge cycle; an electronic control that operates blower and blower speed for continuous, wave, or massage pulse modes; and a 20-minute timer.
<b>Premier</b>		A 120V system that includes a 1HP, variable speed blower with integral heater; automatic purge cycle; (2) Chromatherapy mood lights; Automatic Ozone System; an electronic control that operates blower and blower speed for continuous, wave, or massage pulse modes; and a 20-minute timer.
<b>Signature</b>		A 120V system that includes a 1HP, variable speed blower with integral heater; automatic purge cycle; (2) Chromatherapy mood lights; Automatic Ozone System; a digital control with LCD display; low water level and temperature sensors; enhanced user control options; a 20-minute timer; and Bluetooth Sound Immersion System.  Control keypad operates blower and blower speed for continuous, wave, or pulse massage modes, LED Chromatherapy lights, and shows equipment status, water temperature, and time remaining.